

PREISLISTE



LED Aufbauleuchte "DECO"

DALI / Touch dimmbar / 400mm

ART. NR.	WATT	BEZEICHNUNG	Ra/CRI	KELVIN	LICHTSTROM	IP	PREIS CHF exkl. / inkl. MWSt
SPA-099AL-40D schwarz/weiss	40W	LED Aufbauleuchte «DECO» direkt/indirekt 70/30%, 120° DALI / Touch dim, CRI>80 UGR: <19, Schutzklasse I Aluminium, Microprismatic diffuser, 50/60Hz, 95-265V IP40, Ø400x86mm, 3.8kg	80	3000K/4000K einstellbar	4200lm 4300lm	IP40	361.19 / 389.00
30207		Seilpendel schwarz / weiss passend zu DECO Deckenleuchte		Länge max.: 80cm			64.07 / 69.00
30208		Rohrpendel schwarz / weiss passend zu DECO Deckenleuchte		Länge max.: 50cm			64.07 / 69.00



* = ab Lager lieferbar





LED Aufbauleuchte "DECO"

DALI / Touch dimmbar / 600mm/800mm/1000mm

ART. NR.	WATT	BEZEICHNUNG	Ra/CRI	KELVIN	LICHTSTROM	IP	PREIS exkl. / inkl. MWSt
SPA-099AL-60D schwarz/weiss	60W	LED Aufbauleuchte «DECO» direkt/indirekt 70/30%, 120° DALI / Touch dim, CRI>80 UGR: <19 , Schutzklasse I Aluminium, Microprismatic diffuser, 50/60Hz, 95-265V IP40, Ø600x86mm, 5.8kg	80	3000K/4000K einstellbar 3000K/4000K/ 5700K	6200lm 6300lm	IP40	611.89 / 659.00
SPA-099AL-80D schwarz/weiss	80W	LED Aufbauleuchte «DECO» direkt/indirekt 70/30%, 120° DALI / Touch dim, CRI>80 UGR: <19 , Schutzklasse I Aluminium, Microprismatic diffuser, 50/60Hz, 95-265V IP40, Ø800x86mm, 7.8kg	80	3000K/4000K einstellbar 3000K/4000K/ 5700K	8200lm 8300lm	IP40	797.59 / 859.00
SPA-099AL-100D schwarz/weiss	100W	LED Aufbauleuchte «DECO» direkt/indirekt 70/30%, 120° DALI / Touch dim, CRI>80 UGR: <19 , Schutzklasse I Aluminium, Microprismatic diffuser, 50/60Hz, 95-265V IP40, Ø1000x86mm, 9.8kg	80	3000K/4000K einstellbar 3000K/4000K/ 5700K	10200lm 10300lm	IP40	a/A

* = nicht lagernd, 5-6 Wochen Lieferfrist

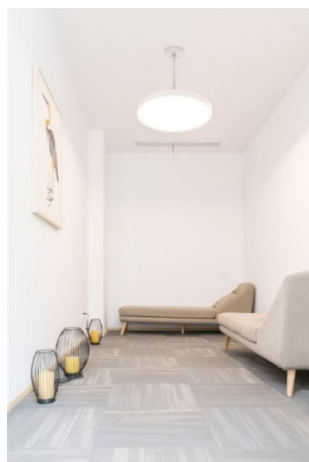

Preise exkl. MWST. Grössere Mengen auf Anfrage. Preisänderungen vorbehalten. Januar 2021



Spatlux GmbH
 Spechtweg 6
 CH-8032 Zürich

T +41 (0)44 586 98 90
 F +41 (0)43 888 42 75
 info@spatalux.ch
 www.spatalux.ch



PREISLISTE



LED-Balkenleuchte 1195mm - L1195xB56xH68mm

Ein/Aus / Notlicht 3h / DALI/PushDim / DALI/PushDim +Notlicht - Netzteil Philips / Osram

ART. NR.	WATT	BEZEICHNUNG	Ra/CRI	KELVIN	LICHTSTROM	IP	PREIS CHF exkl. / inkl. MWSt
SPA-40010	20/25/30/35W einstellbar	LED-Balkenleuchte, 130° weiss, 5 J. Garantie, on/off	80	3000K/4000K 5000K einstellbar	2800/3500lm 4200/4800lm	IP20	64.07 / 69.00
SPA-40011	20/25/30/35W einstellbar	LED-Balkenleuchte, 130° weiss, 5 J. Garantie, Not 3h	80	3000K/4000K 5000K einstellbar	2800/3500lm 4200/4800lm	IP20	147.63 / 159.00
SPA-40014	35W	LED-Balkenleuchte, 130°, weiss, 5 J. Garantie, DALI/PushDim	80	3000K/4000K 5000K einstellbar	2800/3500lm 4200/4800lm	IP20	129.06 / 139.00
SPA-40015	35W	LED-Balkenleuchte, 130° weiss, 5 J. Garantie DALI Not	80	3000K/4000K 5000K einstellbar	2800/3500lm 4200/4800lm	IP20	212.63 / 229.00
SPA-40025	20/25/30/35W einstellbar	LED-Balkenleuchte, 130°, weiss 5 J. Garantie HF-Sensor	80	3000K/4000K 5000K einstellbar	2800/3500lm 4200/4800lm	IP20	110.49 / 119.00
SPA-40020	20/25/30/35W einstellbar	LED-Balkenleuchte, 130°, schwarz , 5 J. Garantie on/off	80	3000K/4000K 5000K einstellbar	2800/3500lm 4200/4800lm	IP20	73.35 / 79.00
SPA-40021	20/25/30/35W einstellbar	LED-Balkenleuchte, 130° schwarz , 5 J. Garantie Not 3h	80	3000K/4000K 5000K einstellbar	2800/3500lm 4200/4800lm	IP20	156.92 / 169.00

LED-Balkenleuchte 1450mm - L1450xB56xH68mm

Ein/Aus / Notlicht 3h / DALI/PushDim / DALI/PushDim +Notlicht - Netzteil: Philips / Osram

ART. NR.	WATT	BEZEICHNUNG	Ra/CRI	KELVIN	LICHTSTROM	IP	PREIS CHF exkl. / inkl. MWSt
SPA-40012	27/34/42/50W einstellbar	LED-Balkenleuchte, 130° weiss, 5 J. Garantie, on/off	80	3000K/4000K 5000K einstellbar	3780/4760lm 5880/7000lm	IP20	82.64 / 89.00
SPA-40013	27/34/42/50W einstellbar	LED-Balkenleuchte, 130° weiss, 5 J. Garantie, Not 3h	80	3000K/4000K 5000K einstellbar	3780/4760lm 5880/7000lm	IP20	166.20 / 179.00
SPA-40016	50W	LED-Balkenleuchte, 130° weiss, 5 J. Garantie, DALI/PushDim	80	3000K/4000K 5000K einstellbar	3780/4760lm 5880/7000lm	IP20	156.92 / 169.00
SPA-40017	50W	LED-Balkenleuchte, 130° weiss, 5 J. Garantie, DALI Not	80	3000K/4000K 5000K einstellbar	3780/4760lm 5880/7000lm	IP20	240.48 / 259.00
SPA-40022	27/34/42/50W einstellbar	LED-Balkenleuchte, 130°, schwarz , 5 J. Garantie on/off	80	3000K/4000K 5000K einstellbar	3780/4760lm 5880/7000lm	IP20	87.28 / 94.00
SPA-40023	27/34/42/50W einstellbar	LED-Balkenleuchte, 130° schwarz , 5 J. Garantie Not 3h	80	3000K/4000K 5000K einstellbar	3780/4760lm 5880/7000lm	IP20	166.20 / 179.00

ART. NR.	BEZEICHNUNG	PREIS CHF exkl. / inkl. MWSt
SPA-40035	Seilpendel-Set 2m (2 Stück)	11.61 / 12.50
SPA-40036	Installationsclips (2 Stück)	3.25 / 3.50

Preisänderungen vorbehalten. Februar 2022



Spatalux GmbH
 Spechtweg 6
 CH-8032 Zürich

T +41 (0)44 586 98 90
 F +41 (0)43 888 42 75
 info@spatalux.ch
 www.spatalux.ch



PREISLISTE



LED-Feuchtraumleuchte 120cm

3 Jahre Garantie

ART. NR.	WATT	BEZEICHNUNG	Ra/ CRI	KELVIN	LICHTSTROM	IP	PREIS CHF exkl. / inkl. MWSt
SPA-40055	25/30/ 35/40W einstellbar	LED-Feuchtraumleuchte on/off Gehäuse: Polycarbonat grau, 120° L1200xB120xH108mm Lebensdauer: 50'000h /L70 bei 25°C	80	3000K/4000K/ 5000K einstellbar	3250-5200lm	IP65	110.49 / 119.00
SPA-40056	25/30/ 35/40W einstellbar	LED-Feuchtraumleuchte HF-Sensor Gehäuse: Polycarbonat grau, 120° L1200xB120xH108mm Lebensdauer: 50'000h /L70 bei 25°C	80	3000K/4000K/ 5000K einstellbar	3250-5200lm	IP65	129.06 / 139.00
SPA-40057	25/30/ 35/40W einstellbar	LED-Feuchtraumleuchte NOT 3H (2W) Gehäuse: Polycarbonat grau, 120° L1200xB120xH108mm Lebensdauer: 50'000h /L70 bei 25°C	80	3000K/4000K/ 5000K einstellbar	3250-5200lm	IP65	175.49 / 189.00

LED-Feuchtraumleuchte 150cm

3 Jahre Garantie

ART. NR.	WATT	BEZEICHNUNG	Ra/ CRI	KELVIN	LICHTSTROM	IP	PREIS CHF exkl. / inkl. MWSt
SPA-40058	35/40/ 45/50W	LED-Feuchtraumleuchte on/off Gehäuse: Polycarbonat grau, 120° L1500xB120xH108mm Lebensdauer: 50'000h /L70 bei 25°C	80	3000K/4000K/ 5000K einstellbar	4550-7800lm	IP65	129.06 / 139.00
SPA-40053- 50	35/40/ 45/50W	LED-Feuchtraumleuchte HF-Sensor Gehäuse: Polycarbonat grau, 120° L1500xB120xH108mm Lebensdauer: 50'000h /L70 bei 25°C	80	3000K/4000K/ 5000K einstellbar	4550-7800lm	IP65	147.63 / 159.00
SPA-40058	35/40/ 45/50W	LED-Feuchtraumleuchte NOT 3H (2W) Gehäuse: Polycarbonat grau, 120° L1500xB120xH108mm Lebensdauer: 50'000h /L70 bei 25°C	80	3000K/4000K/ 5000K einstellbar	4550-7800lm	IP65	194.06 / 209.00

Preisänderungen vorbehalten. Mai 2022



Spatalux GmbH
 Spechtweg 6
 CH-8032 Zürich

T +41 (0)44 586 98 90
 F +41 (0)43 888 42 75
 info@spatalux.ch
 www.spatalux.ch



PREISLISTE



LED-Rohrleuchte TUBE IP69 IK10

ART. NR.	WATT	BEZEICHNUNG	Ra/ CRI	KELVIN	LICHTSTROM	IP	PREIS CHF exkl. / inkl. MWSt
SPA-40052-0	40W	LED-Rohrleuchte TUBE on/off Gehäuse: Polycarbonat+Edelstahl 120° Hochdruck 100bar- IK10 Lebensdauer: 54'000h /L70 bei 25°C L1152xB86xH75mm ohne Durchgangsverdrahtung	80	4000K	5000lm	IP69	189.04 / 203.60
SPA-40052	40W	LED-Rohrleuchte TUBE on/off Gehäuse: Polycarbonat+Edelstahl 120° Hochdruck 100bar- IK10 Lebensdauer: 54'000h /L70 bei 25°C L1152xB86xH75mm mit Durchgangsverdrahtung	80	4000K	5000lm	IP69	199.03 / 214.35
SPA-40053 DALI	40W	LED-Rohrleuchte TUBE DALI Gehäuse: Polycarbonat+Edelstahl 120° Hochdruck 100bar- IK10 Lebensdauer: 54'000h /L70 bei 25°C L1152xB86xH75mm mit Durchgangsverdrahtung	80	4000K	5000lm	IP69	236.03 / 254.20
SPA-40055-0	50W	LED-Rohrleuchte TUBE on/off Gehäuse: Polycarbonat+Edelstahl 120° Hochdruck 100bar- IK10 Lebensdauer: 54'000h /L70 bei 25°C L1152xB86xH75mm ohne Durchgangsverdrahtung	80	4000K	6250lm	IP69	199.03 / 214.35
SPA-40055	50W	LED-Rohrleuchte TUBE on/off Gehäuse: Polycarbonat+Edelstahl 120° Hochdruck 100bar- IK10 Lebensdauer: 54'000h /L70 bei 25°C L1152xB86xH75mm mit Durchgangsverdrahtung	80	4000K	6250lm	IP69	209.01 / 225.10



Preisänderungen vorbehalten. Mai 2022



Spatalux GmbH
 Spechtweg 6
 CH-8032 Zürich

T +41 (0)44 586 98 90
 F +41 (0)43 888 42 75
 info@spatalux.ch
 www.spatalux.ch



PREISLISTE



LED Linearleuchte IP65 / Stossfestigkeit IK08

ART. NR.	WATT	BEZEICHNUNG	Ra/CRI	KELVIN	LICHTSTROM	IP	PREIS CHF exkl. / inkl. MWSt
SPA-066T	30 Watt	LED Linearleuchte IP65 120lm/W, matt, 1200x54x53mm beidseitige Anschlüsse, anreihbar	80	3000K* 4000K 5000K* 6500K*	3600lm	IP65	54.78 / 59.00
SPA-066T-15	40 Watt	LED Linearleuchte IP65 120lm/W, matt, 1500x54x53mm beidseitige Anschlüsse, anreihbar	80	3000K* 4000K* 5000K* 6500K*	4800lm	IP65	82.64 / 89.00
SPA-066SE	1.5m	Seilaufhängung 1,5m 2 Stück Stahlkabel/Baldachin für Deckenabhängung, Edelstahl					6.41 / 6.90

* = nicht lagernd, 2-3 Wochen Lieferfrist

Beidseitig schraubenlose Schnellmontage-Steckklammern zum Aneinanderreihen von bis zu 25 Leuchten, inkl. Zwei Metall-Montageklammern + Schrauben + Dübel Stossfestigkeit IK08

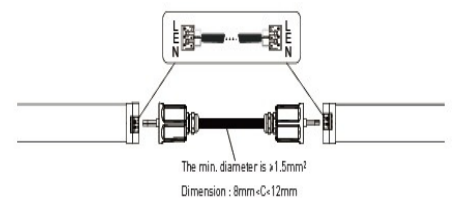

Preise exkl. MWST. Grössere Mengen auf Anfrage. Preisänderungen vorbehalten. August 2019



Spatalux GmbH
 Spechtweg 6
 CH-8032 Zürich

T +41 (0)44 586 98 90
 F +41 (0)43 888 42 75
 info@spatalux.ch
 www.spatalux.ch



PREISLISTE



LED Röhren T8 >Pro- & Power Serie<

ART. NR.	WATT	BEZEICHNUNG	Ra/CRI	KELVIN	LICHTSTROM	IP	PREIS CHF exkl. / inkl. MWSt
SPA-F12B-830 SPA-F12B-840	20 Watt	LED Röhre « PRO Serie » 130lm/W, 2600lumen, Matt, inkl. Starter, Fassung G13, T8 120cm	80	3000K 4000K	2600lm	IP20	14.76 / 15.90
SPA-420-860 SPA-420-840 SPA-420-830	20 Watt	LED Röhre « Power Serie » 160lm/W, 3200lumen, Matt, inkl. Starter, Fassung G13, T8 120cm	80	6000K 4000K* 3000K*	3200lm	IP20	20.89 / 22.50
SPA-520-860 SPA-520-840 SPA-520-830	30 Watt	LED Röhre « Power Serie » 160lm/W, 4600lumen, Matt, inkl. Starter, Fassung G13, T8 150cm	80	6000K 4000K 5000K 3000K*	4600lm	IP20	27.76 / 29.90
SPA-F43B-830 SPA-F43B-840 SPA-F43B-860	8 Watt	LED Röhre « PRO Serie » 130lm/W, 1040lumen, Matt, inkl. Starter, Fassung G13, T8 43cm (436mm)	80	3000K 4000K 5000K 6000K*	1040lm	IP20	22.19 / 23.90
SPA-F97B-830 SPA-F97B-840 SPA-F97B-860	12 Watt	LED Röhre « PRO Serie » 130lm/W, 1560lumen, Matt, inkl. Starter, Fassung G13, T8 97cm (976mm)	80	3000K* 4000K 6000K*	1560lm	IP20	26.93 / 29.00

Lieferumfang: LED Röhre und LED Starter

EVG LED Röhren T8 >Power Serie<

ART. NR.	WATT	BEZEICHNUNG	Ra/CRI	KELVIN	LICHTSTROM	IP	PREIS CHF exkl. / inkl. MWSt
EVG-420-860 EVG-420-840 EVG-420-830	20 Watt	LED Röhre « Power Serie » 160lm/W, 3200lumen, Matt, Fassung G13, T8, geeignet für elektronische Vorschaltgeräte 120cm	80	6000K* 4000K 3000K*	3200lm	IP20	25.91 / 27.90
EVG-520-860 EVG-520-840 EVG-520-830	30 Watt	LED Röhre « Power Serie » 160lm/W, 4600lumen, Matt, Fassung G13, T8, geeignet für elektronische Vorschaltgeräte 150cm	80	6000K* 4000K 3000K*	4600lm	IP20	33.33 / 35.90

* = nicht lagernd, 2-3 Wochen Lieferzeit

Preise exkl. MWST. Grössere Mengen auf Anfrage. Preisänderungen vorbehalten. April 2021



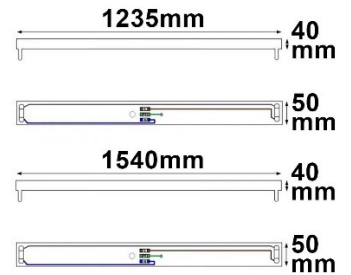

Armatür für LED-Röhren T8

G13 Sockel beidseitig vorverdrahtet, inkl. 3pol Anschlussklemme (L-N-PE)

ART. NR.	BEZEICHNUNG	Masse LxBxH	IP	PREIS CHF exkl. / inkl. MWSt
SPA-113287	120cm Armatür für LED-Röhren T8 Verkabelt, ohne VG, 0-260V Sockeltyp: G13, Aluminium, weiss	1235x50x40mm	IP20	15.62 / 17.90
SPA-113288	150cm Armatür für LED-Röhren T8 Verkabelt, ohne VG, 0-260V Sockeltyp: G13, Aluminium, weiss	1540x50x40mm	IP20	21.26 / 22.90

ACHTUNG: Halterung nicht geeignet für Leuchtstoffröhren!



Feuchtraumleuchte Gehäuse 120/150cm 1xT8 G13, Grau IP65

ohne Leuchtmittel - Kaskadierbar – vorbereitet für Serieninstallation

ART. NR.	BEZEICHNUNG	Masse LxBxH	IP	PREIS CHF exkl. / inkl. MWSt
SPA- 1152544	120cm Feuchtraumleuchte Gehäuse für LED-Röhren T8, Verkabelt, ohne VG, 0-230V Sockeltyp: G13, Kunststoff ABS, grau mit Edelstahlklammern, transparenter Diffusor aus Polystyrol - Für Stalleinrichtungen – Ammoniak beständig	1270x75x90mm	IP65	42.62 / 45.90
SPA-1152545	150cm Feuchtraumleuchte Gehäuse für LED-Röhren T8, Verkabelt, ohne VG, 0-230V Sockeltyp: G13, Kunststoff ABS, grau mit Edelstahlklammern, transparenter Diffusor aus Polystyrol - Für Stalleinrichtungen – Ammoniak beständig	1560x75x90mm	IP65	50.05 / 53.90

ACHTUNG: Halterung nicht geeignet für Leuchtstoffröhren!

Preise exkl. MWST. Grössere Mengen auf Anfrage. Preisänderungen vorbehalten. OKT. 2021



PREISLISTE BRUTTO

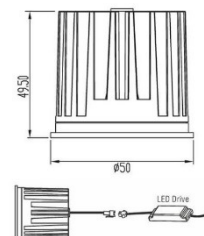

HeloLite LED Module, inkl. Netzteil dimmbar Phasen Ab- & Anschnitt

ART. NR.	WATT	BEZEICHNUNG	Ra/CRI	KELVIN	LICHTSTROM	IP	PREIS CHF exkl. / inkl. MWSt
SPA-011M	9 Watt	LED Modul, inkl. Netzteil	90	2700K	690lm	IP20	44.57 / 48.00
		49.5xØ50mm, (15°/24°/60°) 40° dimmbar Phasen Ab-/Anschnitt		3000K	780lm		
				4000K*	840lm		
SPA-011M	11 Watt	LED Modul, inkl. Netzteil	90	2700K*	900lm	IP20	50.14 / 54.00
		75xØ50mm, (15°/24°/60°) 40° dimmbar Phasen Ab-/Anschnitt		3000K*	950lm		
				4000K*	1050lm		



011-M-075/090-C

M02-090-C

650004

650002

650003

650001

650005

Deckeneinbauringe

ART. NR.	BEZEICHNUNG	Farben	Bohrloch	PREIS CHF exkl. / inkl. MWSt
011M-075	Ø84mm gerundet, schwenkbar	weiss matt/ (schwarz matt)	Ø72-75mm	9.19 / 9.00
011M-090-C	Ø104mm gerundet, schwenkbar	weiss matt/ (schwarz matt)	Ø90mm	11.98 / 12.90
M02-090-C	Ø100cm gerundet	weiss matt/ (schwarz matt)	Ø90mm	14.58 / 15.70
650001	Ø82mm mit Frontaustritt, schwenkbar	Silber	Ø68-72mm	12.91 / 13.90
650003		Silb. Gebürstet		
650002		Chrom		
650004		Weiss		
650005		Schwarz matt		
920829109	Einbaugehäuse ThermoX® Dekorblende Außendurchmesser Ø 125 mm Öffnungsmaß Ø 68 / 75 mm	Weiss	Ø68-75mm	16.63 / 17.90
920829309		Mattnickel		30.55 / 32.90
920829209		Chrom		30.55 / 32.90

* = nicht lagernd, 2-3 Wochen Lieferfrist

Preise exkl. MWST. Grössere Mengen auf Anfrage. Preisänderungen vorbehalten. JANUAR 2020





LED-Einbauspot & Ring 36° 765lm CRI90 IP54

dimmbar Phasen Ab- & Anschnitt / DALI – Gehäuse: Alu-Druckguss

ART. NR.	WATT	BEZEICHNUNG	Ra/CRI	KELVIN	LICHTSTROM	IP	PREIS CHF exkl. / inkl. MWSt
SPA-11032-ws SPA-11032-sz SPA-11032-gr	8 Watt	LED Modul, inkl. Netzteil 36° weiss matt / schwarz matt / alu gebürstet Einbautiefe: 40mm, Bohrloch: 80mm Durchmesser: 95mm, Schutzklasse II dimmbar Phasen Ab-/Anschnitt	90	2700K 3000K	680lm 765lm	IP54	53.85 / 58.00
SPA-11032-D/ws SPA-11032-D/sz SPA-11032-D/gr	8 Watt	LED Modul, inkl. Netzteil 36° weiss matt / schwarz matt / alu gebürstet Einbautiefe: 40mm, Bohrloch: 80mm Durchmesser: 95mm, Schutzklasse II DALI dimmbar	90	2700K 3000K	680lm 765lm	IP54	86.35 / 93.00



LED-Einbauspot & Ring 36° 765lm CRI80 IP44

dimmbar Phasen Ab- & Anschnitt / DALI – Gehäuse: Alu-Druckguss

ART. NR.	WATT	BEZEICHNUNG	Ra/CRI	KELVIN	LICHTSTROM	IP	PREIS CHF exkl. / inkl. MWSt
SPA-11038-ws SPA-11038-sz	8 Watt	LED Modul, inkl. Netzteil 36° weiss matt / schwarz matt / alu gebürstet Einbautiefe: 67mm, Bohrloch: 75-83mm Durchmesser: 90mm, Schutzklasse II dimmbar Phasen Ab-/Anschnitt	80	3000K	765lm	IP44	64.07 / 69.00
SPA-11039-D/ws SPA-11039-D/sz	8 Watt	LED Modul, inkl. Netzteil 36° weiss matt / schwarz matt / alu gebürstet Einbautiefe: 67mm, Bohrloch: 75-83mm Durchmesser: 90mm, Schutzklasse II DALI dimmbar	80	3000K	765lm	IP44	91.92 / 99.00

Preise inkl. MWST. Grössere Mengen auf Anfrage. Preisänderungen vorbehalten. September 2022



PREISLISTE

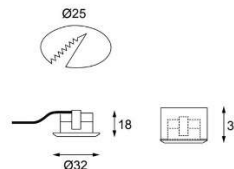

Mini LED-Einbauleucht Ø32mm, 3W, 165lm, IP44

Bohrloch Ø25mm, CRI90, 100° Abstrahlwinkel, dimmbar auf Phasen

ART. NR.	WATT	BEZEICHNUNG	Ra/CRI	KELVIN	LICHTSTROM	IP	Preis CHF exkl. / inkl. MWSt
SPA-DLOF-44-sz	3 Watt	Mini LED-Einbauleuchte Ø32 schwarz Aluminiumdruckguss, Schutzklasse III 3m Anschlusskabel, dimmbar auf Phasen Bohrloch: 25mm - Einbautiefe: 18mm	90	2700K 3000K	165lm	IP44	CHF 45.50 / 49.00
SPA-DLOF-44-ws	3 Watt	Mini LED-Einbauleuchte Ø32 weiss Aluminiumdruckguss, Schutzklasse III 3m Anschlusskabel, dimmbar auf Phasen Bohrloch: 25mm - Einbautiefe: 18mm	90	2700K 3000K	165lm	IP44	CHF 45.50 / 49.00

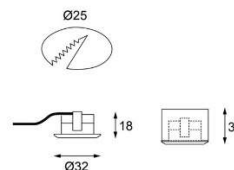
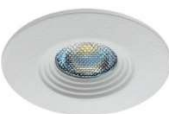

Mini LED-Einbauleucht Ø32mm, 3W, 165lm, IP65

Bohrloch Ø25mm, CRI90, 100° Abstrahlwinkel, dimmbar auf Phasen

ART. NR.	WATT	BEZEICHNUNG	Ra/CRI	KELVIN	LICHTSTROM	IP	Preis CHF exkl. / inkl. MWSt
SPA-DLOF-65-sz	3 Watt	Mini LED-Einbauleuchte Ø32 schwarz Aluminiumdruckguss, Schutzklasse III 3m Anschlusskabel, dimmbar auf Phasen Bohrloch: 25mm - Einbautiefe: 18mm	90	2700K 3000K	165lm	IP54	CHF 64.07 / 69.00
SPA-DLOF-65-ws	3 Watt	Mini LED-Einbauleuchte Ø32 weiss Aluminiumdruckguss, Schutzklasse III 3m Anschlusskabel, dimmbar auf Phasen Bohrloch: 25mm - Einbautiefe: 18mm	90	2700K 3000K	165lm	IP54	CHF 64.07 / 69.00



Anbauring Ø32mm - Anbau-Decke

ART. NR.	BEZEICHNUNG	Farbe	Preis CHF exkl. / inkl. MWSt
SPA-Z-001-sz	Mini Anbauring Ø32 schwarz / weiss	schwarz	CHF 11.14 / 12.00
SPA-Z-001-ws	Aluminiumdruckguss Bohrloch: 25mm - Tiefe: 25mm	weiss	

Preise inkl. MWST. Grössere Mengen auf Anfrage. Preisänderungen vorbehalten. April 2023



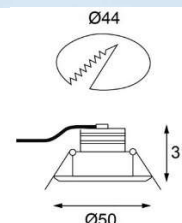

Mini LED-Einbauleucht Ø50mm, 3W, 165lm, IP44

Bohrloch Ø44mm, CRI90, 100° Abstrahlwinkel, dimmbar auf Phasen

ART. NR.	WATT	BEZEICHNUNG	Ra/CRI	KELVIN	LICHTSTROM	IP	Preis CHF exkl. / inkl. MWSt
SPA-DLOT-44-sz 40° schwenkbar	3 Watt	Mini LED-Einbauleuchte Ø50 schwarz Aluminiumdruckguss, Schutzklasse III 3m Anschlusskabel, dimmbar auf Phasen Bohrloch: 44mm - Einbautiefe: 31mm	90	2700K 3000K	165lm	IP54	CHF 54.78 / 59.00
SPA-DLOT-44-ws 40° schwenkbar	3 Watt	Mini LED-Einbauleuchte Ø50 schwarz Aluminiumdruckguss, Schutzklasse III 3m Anschlusskabel, dimmbar auf Phasen Bohrloch: 44mm - Einbautiefe: 31mm	90	2700K 3000K	165lm	IP54	CHF 54.78 / 59.00



LED-Konverter für MINI ONE

ART. NR.	WATT	BEZEICHNUNG	IP	Preis CHF exkl. / inkl. MWSt
BG-SLC1210	18 Watt	700mA/18W, 9-18V, dimmbar Phase, inklusive Steckverteiler für 3-6 Leuchten, Schutzklasse II, 5 Jahre Garantie	für 3 - 6 Leuchten IP20	CHF 59.33 / 63.90
BG-SLC1210	6 Watt	700mA/6W, 3-6V, dimmbar Phase, inklusive Steckverteiler für 1-2 Leuchten, Schutzklasse II, 5 Jahre Garantie	für 1 - 2 Leuchten IP20	CHF 45.50 / 49.00



Beschreibung

Mini LED Einbauleuchten Hohldecken, ohne Betriebsgerät, dimmbar, 3m Anschlusskabel mit Stecksystem, Farbwiedergabe CRI 90, Mittlere Lebensdauer 50000 Stunden/L90/B10, Ausstrahlwinkel 100°, Schutzgrad IP44 (von unten), Schutzklasse III, Normen: CE, Gehäuse aus Aluminiumdruckguss, Gehäusefarbe weiss, geschlossene Linse, Befestigung mit Klemmfedern, 5 Jahre Garantie.



PREISLISTE

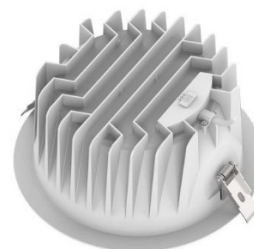

LED-Downlight 3000/4000/5700K einstellbar DALI PUSH-Dimmbar – Schutzklasse II

ART. NR.	WATT	BEZEICHNUNG	Ra/CRI	KELVIN	LICHTSTROM	IP	PREIS CHF exkl. / inkl. MWST
SPA-12024-DA	10 Watt	LED-Downlight weiss ALU-Druckguss, Ø145x77mm Bohrloch 125-135mm Abstrahlwinkel 75° Dimmbar DALI Push-dim	80	3000K/4000K/ 5700K einstellbar	920-1000lm	IP54	110.49 / 119.00
SPA-12025-DA	18 Watt	LED-Downlight weiss ALU-Druckguss, Ø172x90mm Bohrloch 150-165mm Abstrahlwinkel 75° Dimmbar DALI Push-dim	80	3000K/4000K/ 5700K einstellbar	1600-1800lm	IP54	119.78 / 129.00
SPA-12026-DA	25 Watt	LED-Downlight weiss ALU-Druckguss, Ø228x207mm Bohrloch 200-210mm Abstrahlwinkel 75° Dimmbar DALI Push-dim	80	3000K/4000K/ 5700K einstellbar	2600-2800lm	IP54	156.92 / 169.00
SPA-12027-DA	35 Watt	LED-Downlight weiss ALU-Druckguss Ø280x123mm Bohrloch 230-260mm Abstrahlwinkel 75° Dimmbar DALI Push-dim	80	3000K/4000K/ 5700K einstellbar	3600-3800lm	IP54	184.77 / 199.00

Einbetoniergehäuse auf Anfrage erhältlich!



Preise exkl. MWST. Grössere Mengen auf Anfrage. Preisänderungen vorbehalten. August 2021



Spatalux GmbH
 Spechtweg 6
 CH-8032 Zürich

T +41 (0)44 586 98 90
 F +41 (0)43 888 42 75
 info@spatalux.ch
 www.spatalux.ch



PREISLISTE



LED Deckeneinbauleuchte, inkl. Netzteil dimmbar Phasen Ab- & Anschnitt

ART. NR.	WATT	BEZEICHNUNG	Ra/CRI	KELVIN	LICHTSTROM	IP	PREIS CHF exkl. / inkl. MWSt
SPA-97DL3-D weiss	13 Watt	LED Downlight, inkl. Netzteil 230mA, Ø110x38mm, 90° DIM Phasenabschnitt/-anschnitt Bohrloch: Ø90-95mm	80	2700K* 3000K* 4000K-Lager	790lm 890lm 990lm	IP54	27.76 / 29.90



ART. NR.	WATT	BEZEICHNUNG	Ra/CRI	KELVIN	LICHTSTROM	IP	PREIS CHF exkl. / inkl. MWSt
SPA-97DL6-D weiss	25 Watt	LED Downlight, inkl. Netzteil 600mA, Ø190x45mm, 90° DIM Phasenabschnitt/-anschnitt Bohrloch: Ø160-170mm	80	2700K* 3000K* 4000K*	2300lm 2500lm 2750lm	IP54	36.21 / 39.00
SPA-97DL8-D weiss	35 Watt	LED Downlight, inkl. Netzteil 800mA, Ø228-45mm, 90° DIM Phasenabschnitt/-anschnitt Bohrloch: Ø200-210mm	80	2700K* 3000K* 4000K*	3300lm 3500lm 3800lm	IP54	45.50 / 49.00

* = nicht lagernd, 2-3 Wochen Lieferfrist

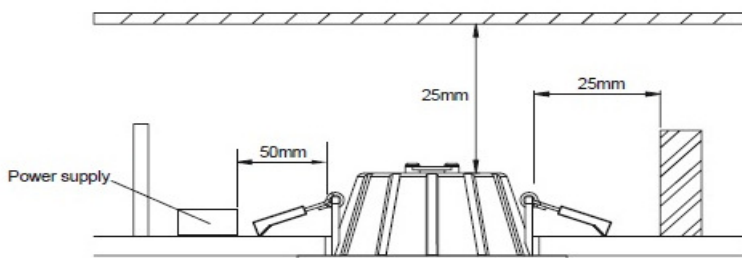

Preise exkl. MWST. Grössere Mengen auf Anfrage. Preisänderungen vorbehalten. JANUAR 2022



Preisliste

LED 9.6W, CRI90 Strips, 24V, IP20

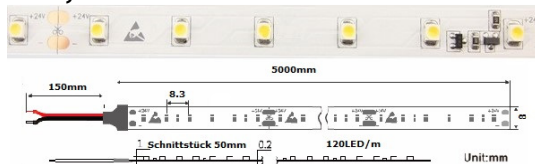

ART. NR.	WATT	Spezifikationen	Ra/CRI	KELVIN	LICHTSTROM	IP	PREIS 5m
NEU SPA-2216A60	9,6 Watt	93lm/W, 24V, 120LEDs/m, dimmbar, Schnitt-Stück 50mm, Abstand LEDs 8mm, Breite 8mm, Höhe 2mm, CV=constant voltage	90	2200K 2700K 3000K 4000K	700lm 750lm 800lm 900lm	IP20	CHF 79.00 Inkl. MWST

LED 13W, CRI90 Strips, 24V, IP20

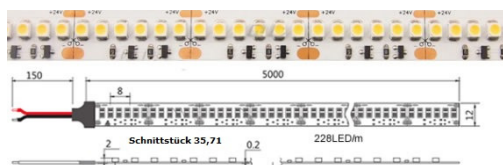

ART. NR.	WATT	Spezifikationen	Ra/CRI	KELVIN	LICHTSTROM	IP	PREIS 5m
NEU SPA-2835A112 SA-150lm/W	13 Watt	150lm/W, 24V, 224LEDs/m, dimmbar, Schnitt-Stück 35,71mm Abstand LEDs 4,4mm, Breite 12mm, Höhe 2mm, CC-IC = constant current	>90	2700K 3000K 4000K	1700lm 1750m 1850lm	IP20	CHF 183.00 Inkl. MWST

LED 15W, CRI80 Strips, 24V, IP20

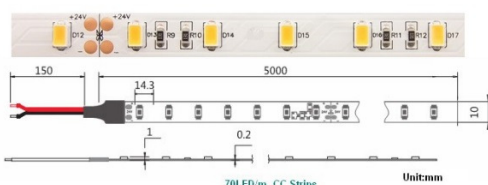
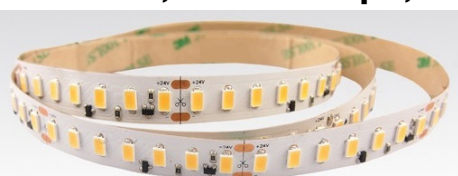

ART. NR.	WATT	Spezifikationen	Ra/CRI	KELVIN	LICHTSTROM	IP	PREIS 5m
NEU SPA-5630A35	15 Watt	140lm/W, 24V, 70LEDs/m, dimmbar, Schnitt-Stück 10cm Abstand LEDs 14,3mm, Breite 10mm, Höhe 2mm, CC-IC = constant current	80	2700K 3000K 4000K	1900lm 1950lm 2050lm	IP20	CHF 183.00 Inkl. MWST

LED Dim-to-warm 20W, CRI90 Strips, 24V, IP20

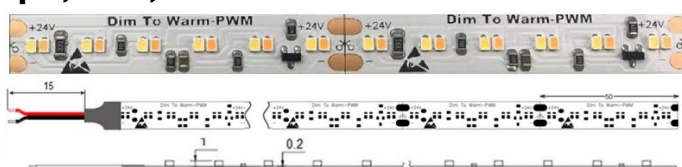

ART. NR.	WATT	Spezifikationen	Ra/CRI	KELVIN	LICHTSTROM	IP	PREIS 5m
NEU SPA-2216A120 DTW kein Controller nötig	20 Watt	95lm/W, 24V, 240LEDs/m, dimmbar, Schnitt-Stück 50mm, Abstand LEDs 4mm Breite 10mm Höhe 2mm, CV=constant voltage dim to warm PWM	90	1800-2800K	1780-1900lm	IP20	CHF 189.00 Inkl. MWST



LED 18W, CRI90/99 Strips, 24V, IP20

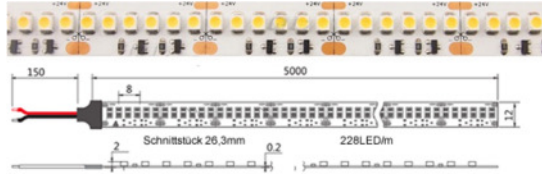

ART. NR.	WATT	BEZEICHNUNG	Ra/CRI	KELVIN	LICHTSTROM	IP	PREIS 5m
SPA-3528A114	18 Watt	84lm/W, 24V, 228LEDs/m, dimmbar, Schnitt-Stück 26.3mm, Abstand LEDs 4.4mm, Breite 12mm, Höhe 2mm, CC-IC = constant current	90	2700K 3000K 4000K (6500K)	1450lm 1500lm 1600lm 1800lm	IP20	CHF 183.00 Inkl. MWST
SPA-3528A114-FS	18 Watt	83lm/W, 24V, 228LEDs/m, dimmbar, Schnitt-Stück 26.3mm, Abstand LEDs 4.4mm, Breite 12mm, Höhe 2mm, CC-IC = constant current	99	(2700K) 3000K (4000K) (6500K)	1350lm 1400lm 1500lm 1700lm	IP20	CHF 189.00 Inkl. MWST

CC, IC LED Bänder können mit normalen 24V Netzteile betrieben werden.

LED COB 18W, CRI90 Strips, 24V, IP20

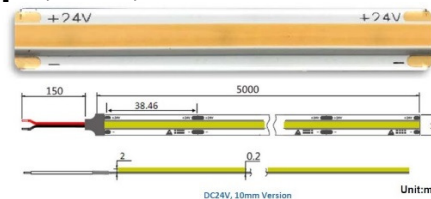
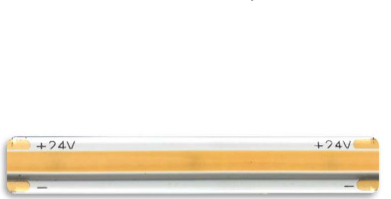

ART. NR.	WATT	Spezifikationen	Ra/CRI	KELVIN	LICHTSTROM	IP	PREIS 5m
NEU SPA-603A264 COBW	18 Watt	83lm/W, 24V, 528LEDs/m, dimmbar, Schnitt-Stück 38,46mm Abstand LEDs 0mm, Breite 10mm, Höhe 2mm CV=constant voltage	90	(2700K) 3000K (4000K)	1400lm 1450lm 1500lm	IP20	CHF 159.00 Inkl. MWST

LED 22W, CRI80 Strips, 24V, IP20

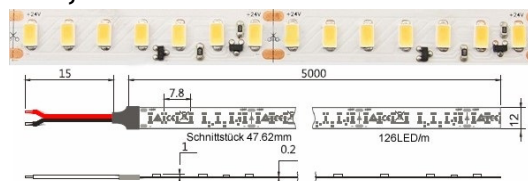

ART. NR.	WATT	BEZEICHNUNG	Ra/CRI	KELVIN	LICHTSTROM	IP	PREIS 5m
SPA-5630A63	22 Watt	127lm/W, 24V, 126LEDs/m, dimmbar, Schnitt-Stück 55,5mm, Abstand LEDs 8mm, Breite 12mm, Höhe 2mm CC-IC = constant current	80	2700K 3000K 4000K 6000K	2800lm 2850lm 2900lm 3000lm	IP20	CHF 229.00 Inkl. MWST
NEU SPA-2835A64	22 Watt	180lm/W, 24V, 128LEDs/m, dimmbar, Schnitt-Stück 62,5mm, Abstand LEDs 7.8mm, Breite 12mm, Höhe 2mm CC-IC = constant current	80	2700K 3000K 4000K (6000K)	3650lm 3700lm 3900lm 4000lm	IP20	CHF 229.00 Inkl. MWST



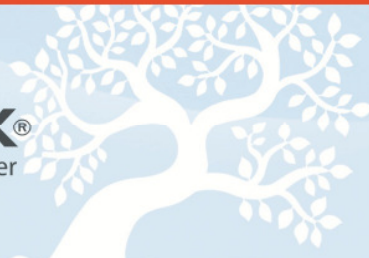

LED 7W/15W, RGB Strips, 24V, IP20



ART. NR.	WATT	BEZEICHNUNG	Ra/CRI	KELVIN	LICHTSTROM	IP	PREIS 5m
RGB-5050A15	7,2 W	36lm/W, 24V, 30LEDs/m, dimmbar, Schnitt-Stück 10cm, Abstand LEDs 33mm, Breite 10mm, Höhe 2mm, CV	RGB		230lm	IP20	CHF 79.00 Inkl. MWST
RGB-5050A30	14,4 W	30lm/W, 24V, 60LEDs/m, dimmbar, Schnitt-Stück 10cm, Abstand LEDs 17mm, Breite 10mm, Höhe 2mm, CV	RGB		450lm	IP20	CHF 119.00 Inkl. MWST

LED RGBW 23W, CRI90 Strips, 24V, IP20

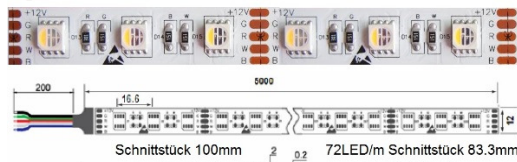
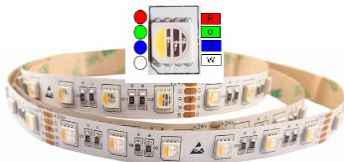

ART. NR.	WATT	BEZEICHNUNG	Ra/CRI	KELVIN	LICHTSTROM	IP	PREIS 5m
SPA-5050A36CX4	23 Watt	57lm/W, 24V, 72LEDs/m, dimmbar, Schnitt-Stück 100mm, Abstand LEDs 14.2mm, Breite 12mm, Höhe 2mm, CV 4in1 Chip Technologie	90	2700K 3000K (4000K/6500K) Rot: 620-630 blau:465-470 grün: 520-525 gelb: 590-595	1000lm 1050lm (1100lm 1150lm)	IP20	CHF 145.00 Inkl. MWST

LED WRGBP 24W, CRI80 Strips, 24V, IP20

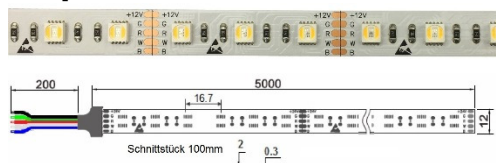

ART. NR.	WATT	BEZEICHNUNG	Ra/CRI	KELVIN	LICHTSTROM	IP	PREIS 5m
SPA-F5050AWCW	24 Watt	54lm/W, 24V, 60LEDs/m, dimmbar, Schnitt-Stück 100mm, Abstand LEDs 16.7mm, Breite 12mm, Höhe 2mm, CV 5in1 Chip Technologie	80	2600K-RGB- 6000K Rot: 620-625 blau:465-470 grün: 520-525 gelb: 590-595	1200lm 1250lm 1300lm 1370lm	IP20	CHF 159.00 Inkl. MWST



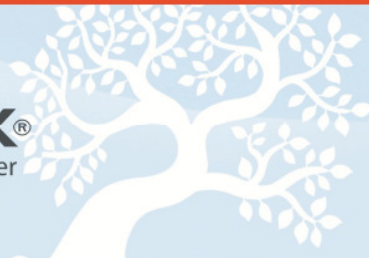

LED-Strip für liegende Rundungen 10W, CRI90, 24V, IP20/IP67

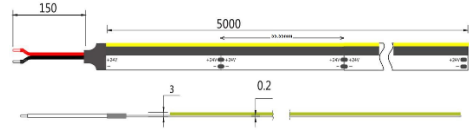

ART. NR.	WATT	BEZEICHNUNG	Ra/CRI	KELVIN	LICHTSTROM	IP	PREIS 5m
SPA-603X189-20	10 Watt	45lm/W, 24V, COB LEDs	90	2700K	460lm	IP20	CHF 189.00 Inkl. MWST
		dimmbar		3000K	500lm		
		Schnitt-Stück 55.55mm		4000K	550lm		
		Breite 10mm, Höhe 3mm		(6500K)	650lm		
SPA-603X189-67	10 Watt	45lm/W, 24V, COB LEDs	90	2700K	420lm	IP67	CHF 189.00 Inkl. MWST
		dimmbar		3000K	460lm		
		Schnitt-Stück 55.55mm		4000K	500lm		
		Breite 10mm, Höhe 3mm		(6500K)	600lm		



Preise exkl. MWST. Grössere Mengen auf Anfrage. Preisänderungen vorbehalten. April 2022



Spatalux GmbH
 Spechtweg 6
 CH-8032 Zürich

T +41 (0)44 586 98 90
 F +41 (0)43 888 42 75
 info@spatalux.ch
 www.spatalux.ch



Brutto Preisliste



“Tridonic” LCA Netzteile one4all, DALI/Push Dimmbarer Konstantspannung-LED-Treiber – 5 Jahre Garantie

ART. NR.	WATT	BEZEICHNUNG	VDC	Power Faktor	Ausgangsstrom	IP	PREIS exkl./inkl. MWSt
28001662 DALI/Push DIM	35 W	Eingangsspan.: 198-264Vac Betriebstemp.: -25°C - +50°C, 50-60Hz, Wirkungsgrad 89% Dimmbereich 1-100%, L195xB43xH30,2mm	24V	0.98	1.76A	IP20	90.00 / 96.95
28001663 DALI/Push DIM	60 W	Eingangsspan.: 198-264Vac Betriebstemp.: -20°C - +50°C, 50-60Hz, Wirkungsgrad 93% Dimmbereich 1-100%, L225xB43xH30,2mm	24V	0.98	2.95A	IP20	105.00 / 113.10
28001253 dimmbar DALI/Push	100 W	Eingangsspan.: 198-264Vac Betriebstemp.: -20°C - +50°C, 50-60Hz, Wirkungsgrad 93% Dimmbereich 1-100%, L295xB43xH30mm	24V	0.99	4.68A	IP20	125.02 / 134.65
28001437 dimmbar DALI/Push	150 W	Eingangsspan.: 198-264Vac Betriebstemp.: -20°C - +50°C, 50-60Hz, Wirkungsgrad 93% Dimmbereich 1-100%, L325xB43xH29,8mm	24V	0.99	7.1A	IP20	160.00 / 172.30

MULTIDIM mit PWM - DALI/PUSH, TRIAC, 0/1-10V - SRP-SERIE

SRP-TRIAC- 200-24V	200 W	Eingangsspan.: 200-240Vac Betriebstemp.: -20°C - +45°C, 50-60Hz, Wirkungsgrad 95% Dimmbereich 0.1-100%, L330xB79xH39mm DALI/PUSH, TRIAC, 0/1-10V	24V	0.98	2.95A	IP20	138.35 / 149.00
-----------------------	-------	---	-----	------	-------	------	--------------------



“Tridonic” LC Netzteile 5 Jahre Garantie Konstantspannung-LED-Treiber

ART. NR.	WATT	BEZEICHNUNG	VDC	Power Faktor	Ausgangsstrom	IP	PREIS exkl./inkl. MWSt
87500853 nicht dimmbar	35 W	Eingangsspan.: 198-264Vac Betriebstemp.: -20°C - +50°C, 50-60Hz, Wirkungsgrad 86,5% Masse: L142xB43xH30mm	24V	0.95	1.76A	IP20	35.28 / 38.00
87500667 nicht dimmbar	60 W	Eingangsspan.: 198-264Vac Betriebstemp.: -20°C - +50°C, 50-60Hz, Wirkungsgrad 92% Masse: L225xB43xH30mm	24V	0.95	2.91A	IP20	48.00 / 51.70
87500668 nicht dimmbar	100 W	Eingangsspan.: 198-264Vac Betriebstemp.: -20°C - +50°C, 50-60Hz, Wirkungsgrad 92% Masse: L295xB43xH30mm	24V	0.98	4.86A	IP20	60.00 / 64.60
87500668 nicht dimmbar	200 W	Eingangsspan.: 198-264Vac Betriebstemp.: - 20°C - +50°C, 50-60Hz, Wirkungsgrad 93% Masse: L325xB43xH30mm	24V	0.95	9.40A	IP20	100 / 107.70





“Eaglerise” Netzteile 5 Jahre Garantie

Konstantspannung-LED-Treiber – nicht dimmbar

ART. NR.	WATT	Spezifikationen	VDC	Power Faktor	Ausgangs-Strom	IP	PREIS exkl./inkl. MWSt
LS-30-24 LI	30 W	Eingangsspan.: 176-264Vac Betriebstemp.: -20°C - +45°C, 47-63Hz, Wirkungsgrad 87% Masse: L142xB45xH30,5mm	24V	≥0.9 bei Volllast	1.25A	IP20	32.50 / 35.00
LS-60-24 LI	60 W	Eingangsspan.: 176-264Vac Betriebstemp.: -20°C - +45°C, 47-63Hz, Wirkungsgrad 87% Masse: L170xB45xH30.5mm	24V	≥0.9 bei Volllast	2.5A	IP20	41.78 / 45.00
LS-75-24 LI1	75 W	Eingangsspan.: 176-264Vac Betriebstemp.: -20°C - +45°C, 47-63Hz, Wirkungsgrad 87% Masse: L197xB45xH30.5mm	24V	≥0.9 bei Volllast	3.13A	IP20	45.50 / 49.00
EDP 100V0240LS	100 W	Eingangsspan.: 176-264Vac Betriebstemp.: -20°C - +45°C, 47-63Hz, Wirkungsgrad 87% Masse: L230xB60xH35mm	24V	≥0.9 bei Volllast	4.2A	IP20	54.78 / 59.00
LS-120-24 LI1	120 W	Eingangsspan.: 176-264Vac Betriebstemp.: -20°C - +45°C, 47-63Hz, Wirkungsgrad 87% Masse: L268xB45xH30.5mm	24V	≥0.9 bei Volllast	5A	IP20	59.33 / 63.90
LS-150-24 LI1	150 W	Eingangsspan.: 176-264Vac Betriebstemp.: -20°C - +45°C, 47-63Hz, Wirkungsgrad 87% Masse: L268xB45xH30.5mm	24V	≥0.9 bei Volllast	6.25A	IP20	73.35 / 79.00



“Eaglerise” Netzteile 5 Jahre Garantie - Ultra schmal

Konstantspannung-LED-Treiber – nicht dimmbar

ART. NR.	WATT	Spezifikationen	VDC	Power Faktor	Ausgangs-Strom	IP	PREIS exkl./inkl. MWSt
US-30-24 LR1	30 W	Eingangsspan.: 200-240Vac Betriebstemp.: -20°C - +45°C, 47-63Hz, Wirkungsgrad 85% Masse: L261xB30xH17mm	24V	≥0.95 bei Volllast	1.25A	IP20	41.78 / 45.00
US-60-24 LR1	60 W	Eingangsspan.: 200-240Vac Betriebstemp.: -20°C - +45°C, 47-63Hz, Wirkungsgrad 85% Masse: L329xB30xH17mm	24V	≥0.95 bei Volllast	2.5A	IP20	59.98 / 64.60
US-100-24 LR1	100 W	Eingangsspan.: 176-264Vac Betriebstemp.: -20°C - +45°C, 47-63Hz, Wirkungsgrad 87% Masse: L365xB30xH17mm	24V	≥0.95 bei Volllast	4.17A	IP20	82.64 / 89.00
US-160-24 LR1	160 W	Eingangsspan.: 200-240Vac Betriebstemp.: -20°C - +45°C, 47-63Hz, Wirkungsgrad 85% Masse: L395xB30.5xH21.5mm	24V	≥0.95 bei Volllast	6.67A	IP20	101.12 / 109.00

Grössere Mengen auf Anfrage. Preisänderungen vorbehalten. April 2022



PREISLISTE



LED-Aufbaudownlight schwenkbar

Phasen An-&Abschnitt dimmbar

ART. NR.	WATT	BEZEICHNUNG	Ra/CRI	KELVIN	LICHTSTROM	IP	PREIS CHF exkl. / inkl. MWST
SPA-13021-ws	15 Watt	LED-Aufbaudownlight Ø85x186mm, weiss, 36° Aluminium - Ph. dimmbar	80	3000K	1350lm	IP20	91.92 / 99.00
SPA-13021-sz	15 Watt	LED-Aufbaudownlight Ø85x186mm, schwarz, 36° Aluminium - Ph. dimmbar	80	3000K	1350lm	IP20	91.92 / 99.00



LED-Anbauleuchte 10W+1.6W direkt/indirekt

Phasen An-&Abschnitt dimmbar

ART. NR.	WATT	BEZEICHNUNG	Ra/CRI	KELVIN	LICHTSTROM	IP	PREIS CHF exkl. / inkl. MWST
SPA-13155-ws	10 Watt	LED-Anbaudownlight Ø120x55mm, Weiss, 52° Aluminium - Ph. Dimmbar direct/indirekt	90	3000K	1180lm	IP20	143.91 / 155.00
SPA-13155-sz	10 Watt	LED-Anbaudownlight Ø120x55mm, Weiss, 52° Aluminium - Ph. Dimmbar direct/indirekt	90	3000K	1180lm	IP20	143.91 / 155.00

Grössere Mengen auf Anfrage. Preisänderungen vorbehalten. April 2021



Spatalux GmbH
 Spechtweg 6
 CH-8032 Zürich

T +41 (0)44 586 98 90
 F +41 (0)43 888 42 75
 info@spatalux.ch
 www.spatalux.ch



PREISLISTE



LED-Aufbauleuchte 12W 3000K/4000K einstellbar Ø250x58mm / on/off / Weiss oder Schwarz / IP65

ART. NR.	WATT	BEZEICHNUNG	Ra/CRI	KELVIN	LICHTSTROM	IP	PREIS CHF exkl. / inkl. MWSt
SPA-30201sz SPA-30209ws	12 Watt	LED-Aufbauleuchte on/off Vollmond Abstrahlwinkel 110° Aluminium + Kunststoff IK10 Gehäuse: schwarz / weiss	80	3000K / 4000K einstellbar	1050-1250lm	IP65	129.06 / 139.00
SPA-30202sz SPA-30213ws	12 Watt	LED-Aufbauleuchte on/off halbmond Abstrahlwinkel 110° Aluminium + Kunststoff IK10 Gehäuse: Schwarz / Weiss	80	3000K / 4000K einstellbar	1050-1250lm	IP65	129.06 / 139.00

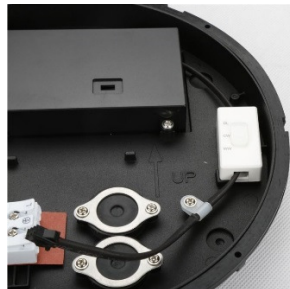

Preise exkl. MWST. Grössere Mengen auf Anfrage. Preisänderungen vorbehalten. Oktober 2021



PREISLISTE



SPA-002W



SPA-003W



SPA-004W

LED Wand-/Deckenleuchte Aluminium, IP65

on/off / Bewegungsmelder / Notfall Batterie, 280x78mm

ART. NR.	WATT	BEZEICHNUNG	Ra/CRI	KELVIN	LICHTSTROM	IP	PREIS CHF exkl. / inkl. MWSt
SPA-002W SPA-003W SPA-004W	10 Watt	LED Wand-/Deckenleuchte dimmbar, on/off, 280x78mm Gehäuse: schwarz / weiss	80	3000K / 4000K 5000K	800lm	IP65	162.49 / 175.00
SPA-002WS SPA-003WS SPA-004WS	10 Watt	LED Wand-/Deckenleuchte dimmbar, SENSOR, 280x78mm Gehäuse: schwarz / weiss	80	3000K / 4000K 5000K	800lm	IP65	171.77 / 185.00
SPA-002WE SPA-003WE SPA-004WE	10 Watt	LED Wand-/Deckenleuchte dimmbar, Notfall Batterie 3h, 280x78mm Gehäuse: schwarz / weiss	80	3000K / 4000K 5000K	800lm	IP65	184.77 / 199.00
SPA-002WSE SPA-003WSE SPA-004WSE	10 Watt	LED Wand-/Deckenleuchte dimmbar, SENSOR Notfall Batterie 3h, 280x78mm Gehäuse: schwarz / weiss	80	3000K / 4000K 5000K	800lm	IP65	CHF a/A

LED Wand-/Deckenleuchte Aluminium, IP65

on/off / Bewegungsmelder / Notfall Batterie, 280x78mm

ART. NR.	WATT	BEZEICHNUNG	Ra/CRI	KELVIN	LICHTSTROM	IP	PREIS CHF exkl. / inkl. MWSt
SPA-002W SPA-003W SPA-004W	20 Watt	LED Wand-/Deckenleuchte dimmbar, on/off, 280x78mm Gehäuse: schwarz / weiss	80	3000K / 4000K 5000K	1600lm	IP65	171.77 / 185.00
SPA-002WS SPA-003WS SPA-004WS	20 Watt	LED Wand-/Deckenleuchte dimmbar, SENSOR, 280x78mm Gehäuse: schwarz / weiss	80	3000K / 4000K 5000K	1600lm	IP65	181.06 / 195.00
SPA-002WE SPA-003WE SPA-004WE	20 Watt	LED Wand-/Deckenleuchte dimmbar, Notfall Batterie 3h, 280x78mm Gehäuse: schwarz / weiss	80	3000K / 4000K 5000K	1600lm	IP65	194.06 / 209.00
SPA-002WSE SPA-003WSE SPA-004WSE	20 Watt	LED Wand-/Deckenleuchte dimmbar, SENSOR Notfall Batterie 3h, 280x78mm Gehäuse: schwarz / weiss	80	3000K / 4000K 5000K	1600lm	IP65	CHF a/A

Grössere Mengen auf Anfrage. Preisänderungen vorbehalten. Oktober 2018



PREISLISTE

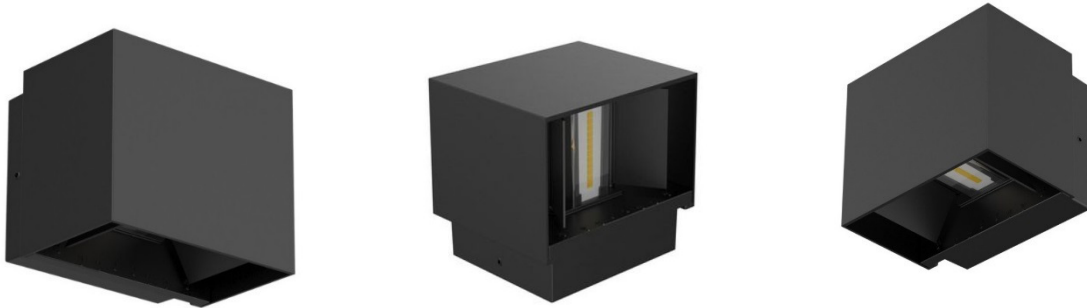

LED-Wandleuchte 2x5Watt Winkel einstellbar Schwarz RAL9005

ART. NR.	WATT	BEZEICHNUNG	Ra/CRI	KELVIN	LICHTSTROM	IP	PREIS CHF exkl. / inkl. MWSt
SPA-WL20	2 x 5 Watt	LED-Wandleuchte schwarz 120x96.8x100mm, 15°-120° Aluminium, nicht dimmbar	80	3000K	2 x 450lm	IP65	101.21 / 109.00

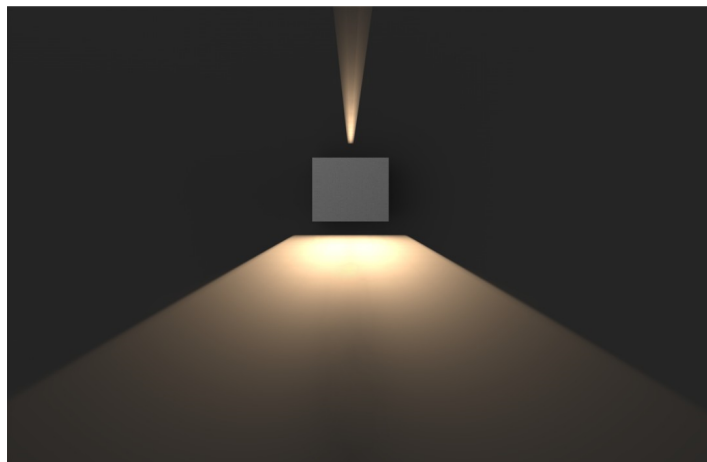
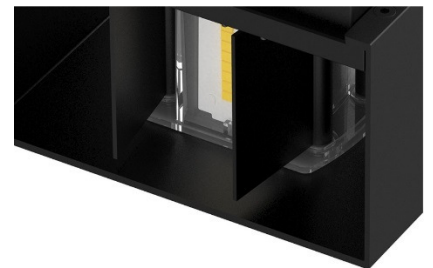
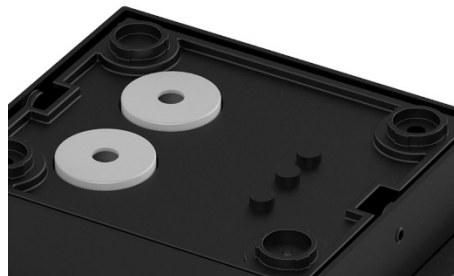
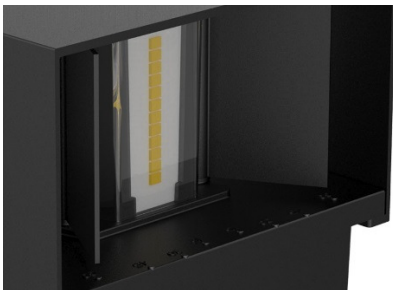

Preise exkl. MWST. Grössere Mengen auf Anfrage. Preisänderungen vorbehalten. April 2021



Spatalux GmbH
Spechtweg 6
CH-8032 Zürich

T +41 (0)44 586 98 90
F +41 (0)43 888 42 75
info@spatalux.ch
www.spatalux.ch



PREISLISTE



LED Strahler «Quader» 10W – 200W

Phasen Ab- & Anschnitt dimmbar

ART. NR.	WATT	BEZEICHNUNG	Ra/CRI	KELVIN	LICHTSTROM	IP	PREIS CHF exkl. / inkl. MWSt
22341	10W	LED Strahler «Quader» Bridgelux 45mil, 50/60Hz, 95-265V, 100-120° L179xB133xH57, 755g	80	2700K* 3000K 4000K* 5000K/6500K*	850-900lm	IP65	CHF a/A
22342	20W	LED Strahler «Quader» Bridgelux 45mil, 50/60Hz, 95-265V, 100-120° L201xB166xH77, 950g	80	2700K* 3000K* 4000K* 5000K/6500K*	1600- 1800lm	IP65	CHF a/A
22343	30W	LED Strahler «Quader» Bridgelux 45mil, 50/60Hz, 95-265V, 100-120° L215xB178xH81, 1.240kg	80	2700K 3000K 4000K* 5000K/6500K*	2400-3000lm	IP65	173.63 / 187.00
22344-Triack	50W	LED Strahler «Quader» Bridgelux 45mil, 50/60Hz, 95-265V, 100-120° L253xB194xH95, 1.830kg	80	2700K* 3000K 4000K* 5000K/6500K*	4000-5000lm	IP65	277.62 / 299.00
22346-Triack	100W	LED Strahler «Quader» Bridgelux 45mil, 50/60Hz, 95-265V, 100-120°, (2x50W) L340xB250xH116, 4.450kg	80	2700K* 3000K 4000K* 5000K/6500K*	8500-10000lm	IP65	491.18 / 529.00
22349-Triack	200W	LED Strahler «Quader» Bridgelux 45mil, 50/60Hz, 95-265V, 100-120°, (4x50W) L400x340xH192, 8.540kg	80	2700K* 3000K* 4000K* 5000K/6500K*	16000- 18000lm	IP65	649.03 / 699.00

* = nicht lagernd, 2-3 Wochen Lieferzeit

Auf Wunsch können wir die LED Strahler «Quader» mit LED Chip (Bridgelux 45mil) mit Farbwiedergabeindex von über Ra90 ausrüsten. Sprechen Sie uns an. Wir beraten Sie gerne.

Die Strahler sind auch als 1-10V oder DALI sowie mit Fernbedienung und Funk-Taster verfügbar.

Preise inkl. MWST. Grössere Mengen auf Anfrage. Preisänderungen vorbehalten. Januar 2020



PREISLISTE



LED Strahler «Quader» 10W – 200W

nicht dimmbar

ART. NR.	WATT	BEZEICHNUNG	Ra/CRI	KELVIN	LICHTSTROM	IP	PREIS exkl. / inkl. MWSt
22301	10W	LED Strahler «Quader» Bridgelux 45mil, 50/60Hz, 95-265V, 100-120° L179xB133xH57, 755g	80	2700K* 3000K 4000K* 5000K/6500K*	850-900lm	IP65	39.83 / 42.90
22302	20W	LED Strahler «Quader» Bridgelux 45mil, 50/60Hz, 95-265V, 100-120° L201xB166xH77, 950g	80	2700K* 3000K 4000K* 5000K/6500K*	1600- 1800lm	IP65	73.35 / 79.00
22303	30W	LED Strahler «Quader» Bridgelux 45mil, 50/60Hz, 95-265V, 100-120° L215xB178xH81, 1.240kg	80	2700K 3000K 4000K* 5000K/6500K*	2400-3000lm	IP65	88.21 / 95.00
22344	50W	LED Strahler «Quader» Bridgelux 45mil, 50/60Hz, 95-265V, 100-120° L253xB194xH95, 1.830kg	80	2700K* 3000K 4000K* 5000K/6500K*	4000-5000lm	IP65	129.06 / 139.00
22346	100W	LED Strahler «Quader» Bridgelux 45mil, 50/60Hz, 95-265V, 100-120°, (2x50W) L340xB250xH116, 4.450kg	80	2700K* 3000K 4000K 5000K/6500K*	8500-10000lm	IP65	370.47 / 399.00
22349	200W	LED Strahler «Quader» Bridgelux 45mil, 50/60Hz, 95-265V, 100-120°, (4x50W) L400x340xH192, 8.540kg	80	2700K* 3000K* 4000K* 5000K/6500K*	16000- 18000lm	IP65	463.32 / 499.00

* = nicht lagernd, 2-3 Wochen Lieferfrist

Auf Wunsch können wir die LED Strahler «Quader» mit LED Chip (Bridgelux 45mil) mit Farbwiedergabeindex von über Ra90 ausrüsten. Sprechen Sie uns an. Wir beraten Sie gerne.

Die Strahler sind auch als 1-10V oder DALI sowie mit Fernbedienung und Funk-Taster verfügbar.

Preise exkl. MWST. Grössere Mengen auf Anfrage. Preisänderungen vorbehalten. Januar 2020



PREISLISTE



LED-Rettungszeichenleuchte

Inkl. Piktogramme - Decken- / Wandmontage - Dauerbetrieb/Bereitschaftsbetrieb

ART. NR.	WATT	BEZEICHNUNG	Ra/CRI	KELVIN	LICHTSTROM	IP	PREIS CHF exkl. / inkl. MWSt
SPA-80013-weiss SPA-80014-schwarz	3 Watt	LED-Rettungszeichenleuchte Economy II , 315x223x45mm Erkennungsweite 30m, Kunststoff Einzelbatterie 3h, Schutzklasse II AKKU: LiFePO4 6.4V 600mAh mit Auto Selbsttest	70	5000K	350lm	IP20	147.63 / 159.00
SPA-80025-silber SPA-80026-schwarz		Pendelset für Rettungszeichenleuchte Masse	Max: 1500mm	passend zu	SPA-80013 SPA-80014		39.00 / 42.00
SPA-80016 weiss	3 Watt	LED-Rettungszeichenleuchte SW II , 338x230x43mm Erkennungsweite 30m, Kunststoff Einzelbatterie 3h, Schutzklasse II AKKU: 3.7V Ni-Mh mit Selbsttest	70	6000K	320lm	IP20	129.06 / 139.00
SPA-80015 weiss	3 Watt	LED-Rettungszeichenleuchte WAY , 304x194x108mm Erkennungsweite 30m, Kunststoff Einzelbatterie 3h, Schutzklasse II AKKU: LiFePO4 6.4V 1500mAh mit Auto Selbsttest	70	5000K	350lm	IP20	175.49 / 189.00



LED-Sicherheitsleuchte Flächenoptik

Aufbau-Montage – Autoselbsttest – 3h

ART. NR.	WATT	BEZEICHNUNG	Ra/CRI	KELVIN	LICHTSTROM	IP	PREIS CHF exkl. / inkl. MWSt
SPA-80033 weiss	3 Watt	LED-Sicherheitsleuchte Flächenoptik rund , Ø140x48mm, Einzelbatterie 3h, Kunststoff, AKKU: LiFePO4 6.4V 1500mAh mit Autoselbsttest, Schutzklasse II	80	5000K	240lm	IP20	138.35 / 149.00
SPA-80034-weiss SPA-80035-schwarz	3 Watt	LED-Sicherheitsleuchte Flächenoptik Q , 148x148x33mm Einzelbatterie 3h, Kunststoff, AKKU: LiFePO4 6.4V 1500mAh mit Autoselbsttest, Schutzklasse II	80	5000K	240lm	IP20	138.35 / 149.00

Grössere Mengen auf Anfrage. Preisänderungen vorbehalten. November 2022



PREISLISTE



LED-Sicherheitsleuchte Flächenoptik

Einbau-Montage – Autoselbsttest – 3h

ART. NR.	WATT	BEZEICHNUNG	Ra/CRI	KELVIN	LICHTSTROM	IP	PREIS CHF exkl. / inkl. MWSt
SPA-80037-weiss SPA-80036-schwarz	3 Watt	LED-Sicherheitsleuchte Flächenoptik Einbau Bohrloch: Ø45mm Aussen 45mm Bohrloch: Ø68mm Aussen 80mm Einzelbatterie 3h, Kunststoff, AKKU: LiFePO4 6.4V 1500mAh mit Autoselbsttest, Schutzklasse II	80	5000K	240lm	IP20	138.35 / 149.00



LED-Sicherheitsleuchte 2-6m 220lm

3h, LI-ION, 3.7V, 4W, 2600mAh, Selbsttest Optik Fläche
Dauerbetrieb/Bereitschaftsbetrieb

ART. NR.	WATT	BEZEICHNUNG	Ra/CRI	KELVIN	LICHTSTROM	IP	PREIS CHF exkl. / inkl. MWSt
SPA-80030 Weiss Deckenmontage	4 Watt	Sicherheitsleuchte rund 2-6m, Einzelbatterie 3h 130x130x56.4mm Kunststoff	80	6000K	220lm	IP20	110.49 / 119.00
SPA-80031 Weiss Deckenmontage	4 Watt	Sicherheitsleuchte quadrat 2-6m, Einzelbatterie 3h Ø130x56.4mm, Kunststoff	80	6000K	220lm	IP20	110.49 / 119.00
SPA-80032 Weiss Bohrloch 45mm	4 Watt	Einbau-Sicherheitsleuchte 2-6m, Einzelbatterie 3h Ø55x27.8mm Kunststoff	80	6000K	220lm	IP20	110.49 / 119.00

Grössere Mengen auf Anfrage. Preisänderungen vorbehalten. November 2022



PREISLISTE

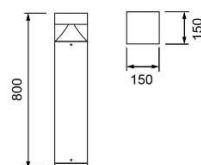
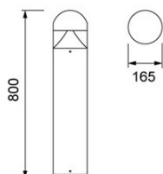

LED-Poller-/Wegleuchte NEVIO RD

Ø165mm H=800mm

ART. NR.	WATT	BEZEICHNUNG	Ra/CRI	KELVIN	LICHTSTROM	IP	PREIS CHF exkl./inkl. MWST
SPA-50010 alu	8W	LED-Poller-/Wegleuchte NEVIO RD Abstrahlwinkel: 360°, nicht dimmbar, Aluminiumdruckguss, 30'000h /L70 bei 25°C Ø165mm H=800mm	80	3000K	800lm	IP65	342.61 / 369.00
SPA-50011 anthrazit	8W	LED-Poller-/Wegleuchte NEVIO RD Abstrahlwinkel: 360°, nicht dimmbar, Aluminiumdruckguss, 30'000h /L70 bei 25°C Ø165mm H=800mm	80	3000K	800lm	IP65	342.61 / 369.00
SPA-50012 anthrazit	8W	LED-Poller-/Wegleuchte NEVIO Square Abstrahlwinkel: 360°, nicht dimmbar, Aluminiumdruckguss, 30'000h /L70 bei 25°C Ø165mm H=800mm	80	3000K	800lm	IP65	360.26 / 388.00



SPA-50040



SPA-15060



LED-Poller-/Wegleuchte DURBAN/QUBIC anthrazit

Ø165mm H=800mm

ART. NR.	WATT	BEZEICHNUNG	Ra/CRI	KELVIN	LICHTSTROM	IP	PREIS CHF exkl./inkl. MWST
SPA-50040 anthrazit	6W	LED-Poller-/Wegleuchte DURBAN Abstrahlwinkel: 90°, nicht dimmbar, IK07 Aluminium, 50'000h /L80/B10, Schutzklasse II B90mm/T128mm/H=700mm - G	80	3000K	450lm	IP65	311.05 / 335.00
SPA-15060 anthrazit	6W	LED-Poller-/Wegleuchte QUBIC Abstrahlwinkel: +/- 60° Winkel einstellbar Phasen-dimmbar, Aluminiumdruckguss 50'000h /L70, L100xB100xH750mm - F	90	3000K	845lm	IP65	194.06 / 209.00

Preisänderungen vorbehalten. Februar 2023



Spatalux GmbH
 Spechtweg 6
 CH-8032 Zürich

T +41 (0)44 586 98 90
 F +41 (0)43 888 42 75
 info@spatalux.ch
 www.spatalux.ch



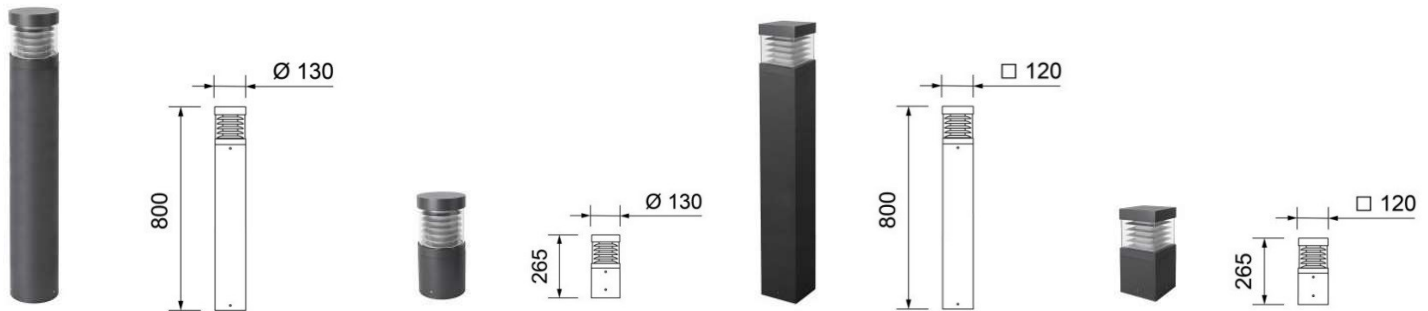

LED-Poller-/Wegleuchte Tom Round II

Ø130mm H=800mm/H265mm 2700K/3000K einstellbar dimmbar auf Phase

ART. NR.	WATT	BEZEICHNUNG	Ra/CRI	KELVIN	LICHTSTROM	IP	PREIS CHF exkl./inkl. MWST
180-300-70 anthrazit	11.5W	LED-Poller-/Wegleuchte Tom Round II Abstrahlwinkel: 360°, dimmbar auf Phase Aluminiumdruckguss, 500mA, 50'000h /L70, Ø130mm H=800mm	80	2700K/ 3000K einstellbar	270lm 300lm	IP65	398.33 / 429.00
180-301-70 anthrazit	11.5W	Tom Round II Mini Abstrahlwinkel: 360°, dimmbar auf Phase, Aluminiumdruckguss, 500mA, 50'000h /L70, Ø130mm H=265mm	80	2700K/ 3000K einstellbar	270lm 300lm	IP65	342.62 / 369.00

LED-Poller-/Wegleuchte Tom Square II

120mm H=800mm/H265mm 2700K/3000K einstellbar dimmbar auf Phase

ART. NR.	WATT	BEZEICHNUNG	Ra/CRI	KELVIN	LICHTSTROM	IP	PREIS CHF exkl./inkl. MWST
180-303-70 anthrazit	11.5W	LED-Poller-/Wegleuchte Tom Square II Abstrahlwinkel: 360°, dimmbar auf Phase Aluminiumdruckguss, 500mA, 50'000h /L70, Ø120mm H=800mm	80	2700K/ 3000K einstellbar	800lm	IP65	398.33 / 429.00
180-304-70 anthrazit	11.5W	Tom Square II Mini Abstrahlwinkel: 360°, dimmbar auf Phase, Aluminiumdruckguss, 500mA, 50'000h /L70, Ø120mm H=265mm	80	2700K/ 3000K einstellbar	800lm	IP65	342.62 / 369.00

Zubehör TOM Round II

ART. NR.	BEZEICHNUNG	Preis CHF exkl./inkl. MWST
180-305-95	Abdeckung	31.47 / 33.90
180-305-97	Bodenflansch	52.00 / 56.00
30285-001-00	Kabelverbinder, IP68, 3-polig	19.96 / 21.50
30285-000-00	Verteilerbox, IP68, 3-polig	29.90 / 32.20

Zubehör TOM Square II

ART. NR.	BEZEICHNUNG	PREIS CHF exkl./inkl. MWST
180-305-96	Abdeckung	22.15 / 23.85
180-305-98	Bodenflansch	52.00 / 56.00
30285-001-00	Kabelverbinder, IP68, 3-polig	19.96 / 21.50
30285-000-00	Verteilerbox, IP68, 3-polig	29.90 / 32.20
Z-Bohrung-spez	Bohrung, 68mm, für Sensor	69.00 / 74.30



Preisänderungen vorbehalten. Februar 2023



Spatalux GmbH
 Spechtweg 6
 CH-8032 Zürich

T +41 (0)44 586 98 90
 F +41 (0)43 888 42 75
 info@spatalux.ch
 www.spatalux.ch



PREISLISTE

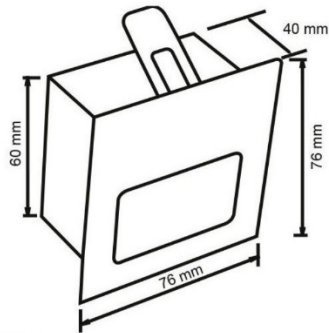

LED-Wandeinbauleuchte Floor Alu gebürstet Einbaugehäuse für Gips und Backstein / Einbetonierungsgehäuse

ART. NR.	WATT	BEZEICHNUNG	Ra/CRI	KELVIN	LICHTSTROM	IP	PREIS CHF exkl. / inkl. MWSt
SPA-37020	2.5W	LED-Wandeinbauleuchte Floor Alu gebürstet, Aluminium Abstrahlwinkel: diffus, Einbautiefe/Breite: 40x60mm Aussenmasse: 76x76x40mm	80	3000K	250lm	IP20	69.54 / 74.90
SPA-37021		Einbaugehäuse für Gips und Backstein zu SPA-37020					19.03 / 20.50
SPA-37022		Einbetonierungsgehäuse zu SPA-37020					109.56 / 118.00



SPA-37022



SPA-37022

Preise exkl. MWST. Grössere Mengen auf Anfrage. Preisänderungen vorbehalten. April 2021





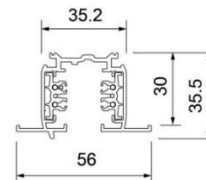
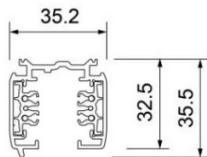









PREISLISTE



3-Phasen + DALI Stromschiene

weiss, ~RAL 9010 / schwarz, ~RAL 9011

Bild	ART. NR. weiss / schwarz	BEZEICHNUNG	Länge	IP	PREIS CHF exkl. / inkl. MWSt
	SPA-3-100 / SPA-4-101	3-Phasen und DALI in einem Aufbaustromschiene	1m	IP20	32.41 / 34.90
	SPA-3-200 / SPA-4-201		2m		59.33 / 63.90
	SPA-3-300 / SPA-4-301		3m		87.19 / 93.90
	SPA-3-400 / SPA-4-401		4m		115.97 / 124.90
	SPA-1-100 / SPA-2-100	3-Phasen und DALI in einem Einbaustromschiene	1m	IP20	37.05 / 39.90
	SPA-1-200 / SPA-2-200		2m		73.35 / 79.00
	SPA-1-300 / SPA-2-300		3m		109.47 / 117.90
	SPA-1-400 / SPA-2-400		4m		141.13 / 152.00

	ART. NR. ws / sz	BEZEICHNUNG	PREIS CHF exkl. / inkl. MWSt
	SPA-6-000/ SPA-6-001	Einschubanschluss Erdung links	10.05 / 11.90
	SPA-7-000/ SPA-7-001	Endkappe	1.95 / 2.10
	SPA-19-000/ SPA-19-000	Seilabhängung	11.98 / 12.90
	SPA-10-000/ SPA-10-001	L-Verbinder Erdung aussen	26.93 / 29.00
	SPA-11-000/ SPA-11-001	Verbinder innenliegend	7.89 / 8.50
	SPA-12-000/ SPA-12-001	Flexibler Verbinder	37.05 / 39.90
	SPA-13-000/ SPA-13-001	T-Verbinder Erdung rechts	33.33 / 35.90
	SPA-20-000/ SPA-20-001	Verbindungs- abhängung	7.34 / 7.90
	SPA-22-000/ SPA-22-001	Abdeckplatte	6.04 / 6.50
	SPA-24-000/ SPA-24-001	Abdeckplatte für L-Verbinder	6.04 / 6.50
	SPA-27-000/ SPA-27-001	DALI-Adapter	18.01 / 19.40

	ART. NR. ws / sz	BEZEICHNUNG	PREIS CHF exkl. / inkl. MWSt
	SPA-5-000/ SPA-5-001	Einschubanschluss Erdung rechts	10.05 / 11.90
	SPA-17-000/ SPA-17-001	Befestigungsklammer	2.41 / 2.60
	SPA-18-000/ SPA-18-001	Stangenabhängung	15.69 / 16.90
	SPA-09-000/ SPA-09-001	L-Verbinder Erdung innen	26.93 / 29.00
	SPA-08-000/ SPA-08-001	Mittelverbinder	37.05 / 39.90
	SPA-15-000/ SPA-15-001	X-Verbinder	48.19 / 51.90
	SPA-14-000/ SPA-14-001	T-Verbinder Erdung rechts, Abzweigung Erdung links	33.33 / 35.90
	SPA-21-000/ SPA-21-001	Displayhaken	1.86 / 2.00
	SPA-23-000/ SPA-23-001	Abdeckplatte für Mittelverbinder	6.04 / 6.50
	SPA-25-000/ SPA-25-001	Abdeckplatte für T-Verbinder	6.04 / 6.50
	SPA-28-000/ SPA-28-001	Monopoint	40.86 / 44.00

Grössere Mengen auf Anfrage. Preisänderungen vorbehalten. FEB. 2022



PREISLISTE



3-Phasen oder 1-Phasen LED Strahler 10W dimmbar dimmbar Phasen Ab- & Anschnitt

ART. NR.	WATT	BEZEICHNUNG	Ra/CRI	KELVIN	LICHTSTROM	IP	PREIS CHF exkl. / inkl. MWSt
SPA-014TL-3PH SPA-014TL-1PH* Weiss/Schwarz	10 Watt	LED Strahler - Netzteil integriert Ø65x97.5x145mm, 45°, 50Hz, AC200-240V, Schutzklasse I DIM Phasenabschnitt/-anschnitt	80	2700K* 3000K 4000K*	700lm 750lm 800lm	IP20	82.64 / 89.00

Deckenmontage LED Strahler 10W dimmbar dimmbar Phasen Ab- & Anschnitt

ART. NR.	WATT	BEZEICHNUNG	Ra/CRI	KELVIN	LICHTSTROM	IP	PREIS CHF exkl. / inkl. MWSt
SPA-014TL-D Weiss/Schwarz	10 Watt	LED Strahler - Netzteil integriert Ø65x97.5x145mm, 45°, 50Hz, AC200-240V, Schutzklasse I DIM Phasenabschnitt/-anschnitt	80	2700K* 3000K* 4000K*	700lm 750lm 850lm	IP20	82.64 / 89.00

* = nicht lagernd, 2-3 Wochen Lieferfrist

Auf Anfrage auch in 90CRI verfügbar Lumen bei 3000K – 650lm

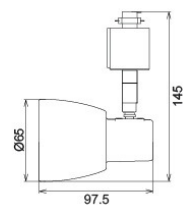
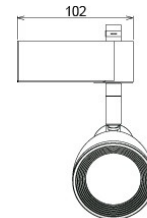

Kompatibel: Mit allen gängigen 3-Phasen Stromschienen wie EUTRAC, GLOBAL, IVELA, IKEA SKENINGE, Stucchi, ERCO

Wir bieten auch 3-Phasen Schienen in unserem Sortiment an. Fragen Sie nach unserer Preisliste. Wir beraten Sie gerne.

Grössere Mengen auf Anfrage. Preisänderungen vorbehalten. JANUAR 2020

